

# Gaskets and gasket sets for the professional repair of automatic transmission systems

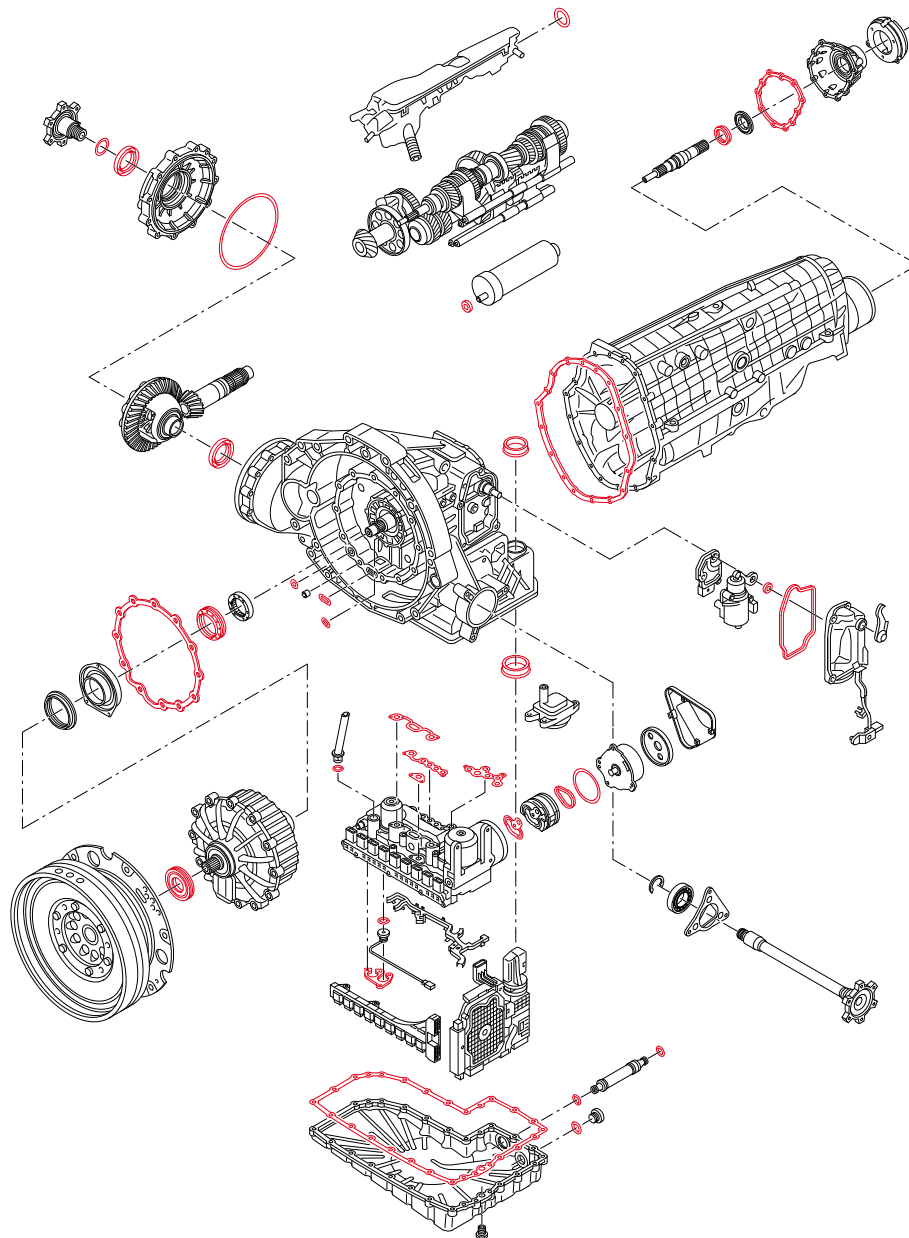

Das Original

Suitable for



BMW						
	A5S325Z	24 10 1 423 380	096.940			
	A5S560Z	24 11 1 421 140	097.620			
	5HP19	1060 298 030	821.570			
GM						
	6T30 (MH9)	2423724	085.930			
Mercedes-Benz						
	720.0, 720.2, 720.3, 720.4	A 305 271 04 80	020.273			
	720.1, 720.5	A 115 271 16 80	020.133			
	722.0, 722.1, 722.2	A 115 271 16 80	020.133			
	722.3	A 126 270 53 00	424.110			
	722.3	A 126 270 61 00	476.060			
	722.3	A 126 271 10 80	921.386			
	722.4	A 201 270 50 01	424.250			
	722.4	A 201 270 48 01	447.310			
	722.4	A 201 271 03 80	445.710			
	722.5	A 126 271 10 80	921.386			
	722.6	A 140 270 65 00	428.390			
	722.6	A 140 271 00 80	295.540			
	722.9	A 220 271 03 80*	428.320			
	722.9	A 220 271 03 80*	428.330			
	722.9	A 220 271 03 80	097.630			
ZF						
	A5S325Z	1060 390 002	096.940			
	5HP19	1060 298 030	821.570		1060 390 002 <del>✗</del>	
	5HP19/FL	1060 298 032	821.540		1056 303 031 <del>✗</del>	
	5HP19/FL	1056 303 031	634.061		FE	
	5HP19/FLA	1060 298 031	821.560		1056 303 031 <del>✗</del>	
	5HP19/FLA	1056 303 031	634.061		FE	
	5HP24	1058 298 022	821.530		0510 314 899 <del>✗</del>	
	5HP24/A	1058 298 023	821.520		1058 303 015 <del>✗</del>	
	6HP19/21/x	1071 298 007	821.450		<del>✗</del> 1058 303 015 <del>✗</del> <del>✗</del>	
	6HP19X	0501 322 077	040.570			
	6HP19/A	1071 298 010	821.460		<del>✗</del> 1071 303 006 & 0501 322 078 <del>✗</del> <del>✗</del>	
	6HP19/A	0501 322 078	125.370			
	6HP26/A-61	1068 298 032/52	821.500		<del>✗</del> 1068 303 012 & 0501 323 155 <del>✗</del> <del>✗</del>	
	6HP26/28/x	1068 298 051	821.480		<del>✗</del> 1058 303 017 & 0501 323 155 <del>✗</del> <del>✗</del>	
	8HP45/x/HIS	1090 298 113	821.470		<del>✗</del> 0501 324 810 <del>✗</del> <del>✗</del>	
	8HP55/A/FL/HIS	1087 298 302	821.550		<del>✗</del> 0501 324 798 <del>✗</del> <del>✗</del>	
	8HP70/x/HIS	1087 298 282	821.430		<del>✗</del> 0501 324 810 <del>✗</del> <del>✗</del>	

Suitable for



**Audi**

	DL382-7F OCK		876.480			
	DL382-7F OCK	OCK 321 371	478.560			
	DL382-7F OCK	OCK 331 261 A	852.050			
	DL382-7F OCK	OCS 409 400	846.250			
	DL382-7F OCK	OCS 409 399	876.400			
	DL382-7Q OCL/OCJ		876.520			
	DL382-7Q OCL/OCJ	OCK 321 371	478.560			
	DL382-7Q OCL/OCJ	OCK 331 261 A	852.050			
	DL382-7Q OCL/OCJ	OCS 409 400	846.250			
	DL382-7Q OCL/OCJ	OCS 409 399	876.400			
	DL382-7Q OCL/OCJ	OB2 409 400	876.330			
	DL501-7Q OB5		876.340			
	DL501-7Q OB5	OB5 311 113 F	451.351			
	DL501-7Q OB5	OB5 301 227 C	852.110			
	DL501-7Q OB5	OB4 409 400 D	290.710			
	DL501-7Q OB5	OAW 409 400	852.090			
	DL501-7Q OB5	OAW 409 399	852.060			
	DL501-7Q OB5	OB2 409 400	876.330			

**Porsche**

	A5B00, A5B01, A5B02, A5B03, A5B04		876.340			
	A5B00, A5B01, A5B02, A5B03, A5B04	OB5 311 113 F	451.351			
	A5B00, A5B01, A5B02, A5B03, A5B04	OB5 301 227 C	852.110			
	A5B00, A5B01, A5B02, A5B03, A5B04	OB4 409 400 D	290.710			
	A5B00, A5B01, A5B02, A5B03, A5B04	OAW 409 400	852.090			
	A5B00, A5B01, A5B02, A5B03, A5B04	OAW 409 399	852.060			
	A5B00, A5B01, A5B02, A5B03, A5B04	OB2 409 400	876.330			

**Volkswagen**

	10	010 398 007 B	094.072			
	10	010 321 371 B	248.339			
	96	096 321 370	096.330			
	09D	09D 321 371	429.960			
	09G	09G 321 370	430.090			
	09K	09K 321 370	901.360			
	09L	09L 321 371 A	125.370			
	OAT	OAT 321 371	040.570			
	OAW	OAW 301 475 B	354.650			
	OAW	OAW 301 463 C	492.290			
	OB5	OB5 321 371 E	451.350			

Key benefits of Elring gaskets and gasket sets:

- No vehicle-specific research required
- Exact match of Elring gaskets and gasket sets for vehicle and automatic transmission
- Gasket set includes all necessary gaskets and seals for repair job
- Time savings thanks to the provision of details on all required gaskets/seals
- All gaskets and parts supplied by gasket specialist in OEM quality

Our gaskets and gasket sets for the professional repair of automatic transmissions offer genuine advantages. What is more, you can look forward to full technical support via our free service hotline.

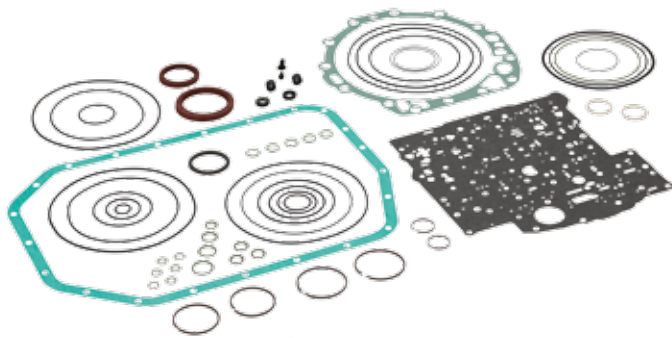

 **821.530**

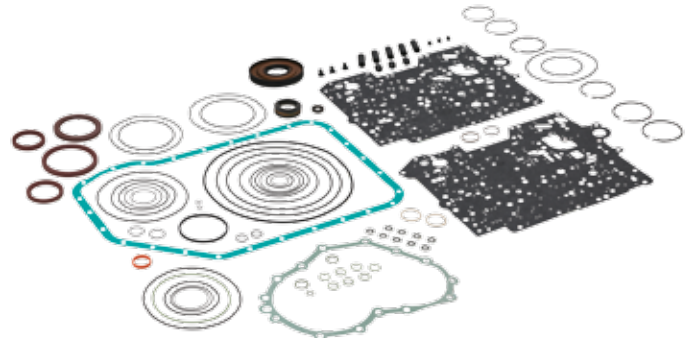

 **821.540**

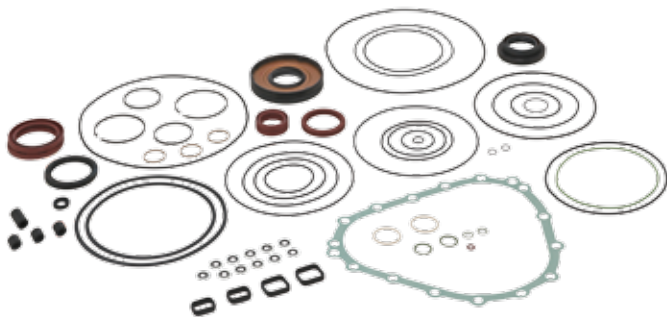

 **821.460**

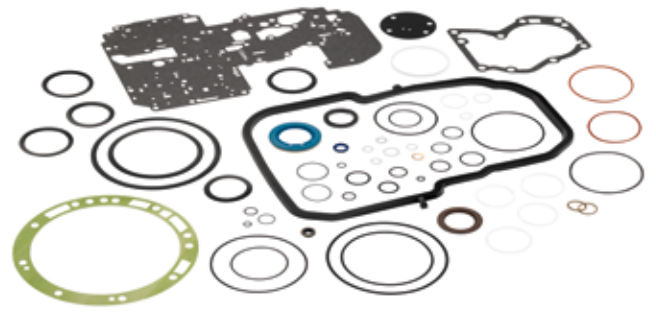

 **447.310**

Elring has added user-friendly gaskets and gasket sets to its range of products, specially designed for the repair of automatic transmissions. These new gaskets and gasket sets cover a range of different transmission designs from major vehicle manufacturers. This is your chance to extend your scope of service and save valuable time. Each gaskets and gasket sets includes everything needed for professional sealing in the field of automatic transmission repair, e.g.:

- Oil pan gaskets
- Oil stem seals
- O-rings
- Retaining rings
- Special rubber components
- Gaskets/seals for the transmission control unit

The demands placed on modern automatic transmissions are enormous. High mileages, significant speeds, and multiple gear changes soon add up, causing gradual wear and tear when it comes to key components. This often results in long-term damage to the system. The following aspects may help you to identify serious issues at an early stage and avoid expensive damage to the transmission:

- The automatic transmission slips during gear changes
- The automatic transmission no longer produces forward momentum
- There is a distinct delay when shifting into drive
- The automatic transmission oil is discolored and smells burnt
- There are unusual sounds such as whining, clunking, or grinding



**Das Original**

ElringKlinger AG | Aftermarket Division  
Max-Eyth-Straße 2 | 72581 Dettingen/Erms | Germany  
Phone +49 7123 724-601 | Fax +49 7123 724-609  
Elring-Service-Hotline  
Phone +49 7123 724-799 | Fax +49 7123 724-798  
service@elring.com | www.elring.com

C510192.0818 EN

